

Features

- 33-inch minimum base cabinet width.
- Acid-resistant enamel finish.
- Double (equal) compartment.
- Top-mount.
- Smart Divide™ lowered divider.
- Single faucet hole with one accessory hole to the right.
- 33" (838 mm) x 22" (559 mm).

Material

- KOHLER® enameled cast iron.

Recommended Accessories

K-9000 P-Trap

Optional Accessories

K-6545 Sponge Caddy

K-8801 Sink Strainer



Codes/Standards









ASME A112.19.1/CSA B45.2

KOHLER® Enameled Cast Iron Kitchen Sink - Lifetime Limited Warranty

See website for detailed warranty information.

Available Color/Finishes

Color tiles intended for reference only.

Color	Code	Description
	0	White
	FF	Sea Salt™
	96	Biscuit
	47	Almond
	FD	Cane Sugar™
	95	Ice™ Grey
	K4	Cashmere
	7	Black Black™

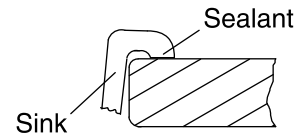
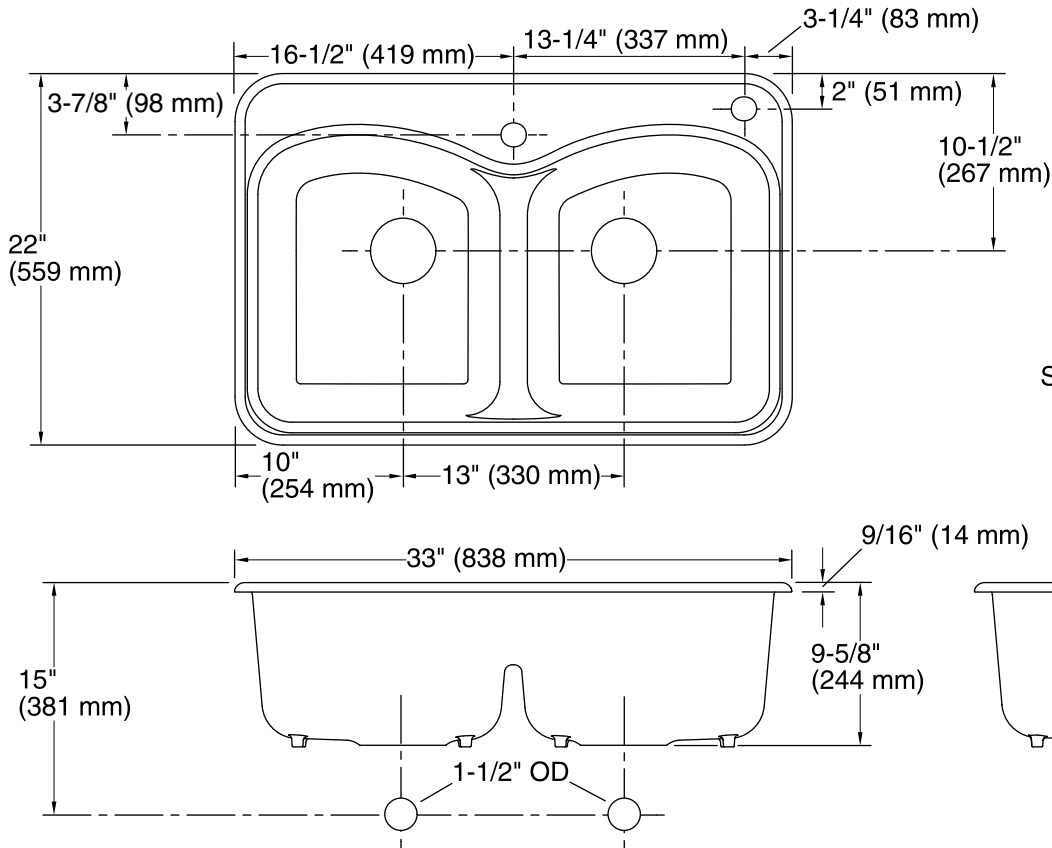

Notes

Install this product according to the installation instructions.

Technical Information

All product dimensions are nominal.

- Bowl configuration: Double equal
- Installation: Top-mount
- Bowl area (Left)
 - Length: 15" (381 mm)
 - Width: 18-3/8" (467 mm)
 - Bowl depth: 9" (229 mm)
- Bowl area (Right)
 - Length: 15" (381 mm)
 - Width: 18-3/8" (467 mm)
 - Bowl depth: 9" (229 mm)
- Number of deck holes: 2
- Faucet hole(s): 1-3/8" (35 mm)
- Drain hole: 3-5/8" (92 mm)
- Template: 1043753-7, required, included