

### Features

- 36-inch minimum base cabinet width.
- Acid-resistant enamel finish.
- Under-mount.
- Three oversized faucet holes with one oversized accessory hole to the right and one oversized accessory hole to the left.
- 33" (838 mm) x 22" (559 mm)

### Material

- KOHLER® enameled cast iron.

### Recommended Accessories

K-9000 P-Trap

### Optional Accessories

K-5807 36" Under-mount Sink Kit

K-6246 Cutting Board

K-6255 Sink Rack

K-8801 Sink Strainer

### Components

Product includes:

K-6194 Utility Rack with Soaking Cup

K-6237 Sink Rack

K-6239 Colander with Cutting Board

1054375 Under-mount Sink Kit, 23"



### Codes/Standards

















ASME A112.19.1/CSA B45.2

### KOHLER® Enameled Cast Iron Kitchen Sink - Lifetime Limited Warranty

See website for detailed warranty information.

### Available Color/Finishes

*Color tiles intended for reference only.*

Color	Code	Description
	0	White
	FF	Sea Salt™
	96	Biscuit
	47	Almond
	FD	Cane Sugar™
	NY	Dune
	95	Ice™ Grey
	G9	Sandbar
	33	Mexican Sand™
	K4	Cashmere
	FT	Basalt
	58	Thunder™ Grey
	20	Suede
	KA	Black 'n Tan
	FP	Caviar
	7	Black Black™

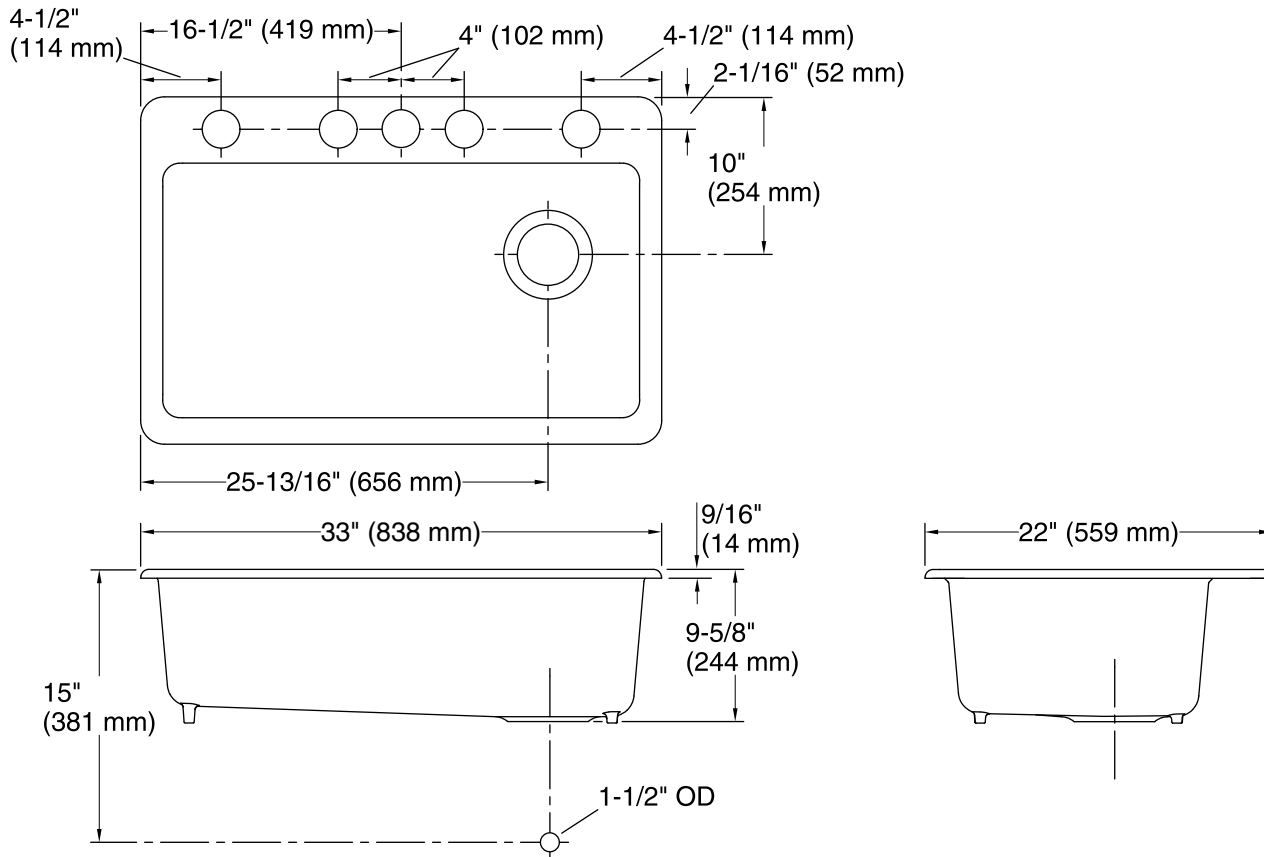

## Technical Information

All product dimensions are nominal.

Bowl configuration:	Single
Installation:	Under-mount
Bowl area (Only)	Length: 30-1/4" (768 mm) Width: 15-13/16" (402 mm) Bowl depth: 9" (229 mm)
Number of deck holes:	5
Faucet hole(s):	2-3/8" (60 mm)
Drain hole:	3-7/8" (98 mm)
Template:	1166727-7, required, included

## Notes

Install this product according to the installation instructions.

**NOTICE:** Countertop manufacturer or cutter must use the cut-out template provided with the product, or a current one provided by Kohler Co. (call 1-800-4-KOHLER). Kohler Co. is not responsible for cutout errors when the incorrect cut-out template is used.